

HX-RA

Programming Manual

One line LED moving message sign



Contents



General information	
The constitution of product	1
Introduction of IR remote	2
The start up message	3
Input simple text	4
Input simple text	
Create a new text	4
Edit an existed text	5
Edit text	
Insert time and date in the text	5
Insert picture	6
Insert special symbol	6
Set font and color	7
Input upper and lower case	8
Move cursor	9
Switch cursor from the front to the end	10
Text test	11
Set display text mode	12
Set display text speed	13
Set text stop time	14
Delete text	15
Edit picture	
Create a new picture	16
Edit an existed picture	16
Set cursor different state	17
Set cursor color	17
Set picture speed	18
Delete picture	19
Change code	20
Delete text and picture	21
Set display time and date	22
Control voice	22
Insert code and set code	23

Expanded mode	
Set expanded mode	24
Edit display list	25
Set text display time and date	26
Set display mode	27
Delete display list	27
Set turn on/off time	28
Set screen number	28
Input International character	29
Set font	30
Communication connection	33
Specification	35

General information

The constitution of product

Open packaging box which is including:

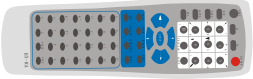
Title	Quantity		
Sign	1 pc		
Screw	6pcs	2.5*5:4pcs	
		M6*15:2pcs	
Installation parts	2pcs	For installation and fixation	
IR remote	1pc	Operation Edit	
Manual	1pc		
Power	1pc		
Equip chain	2pcs		
Software CD	1set		

If you find some parts aren't in the box or destruction, please contact the distributors.

2 AAA batteries for IR remote

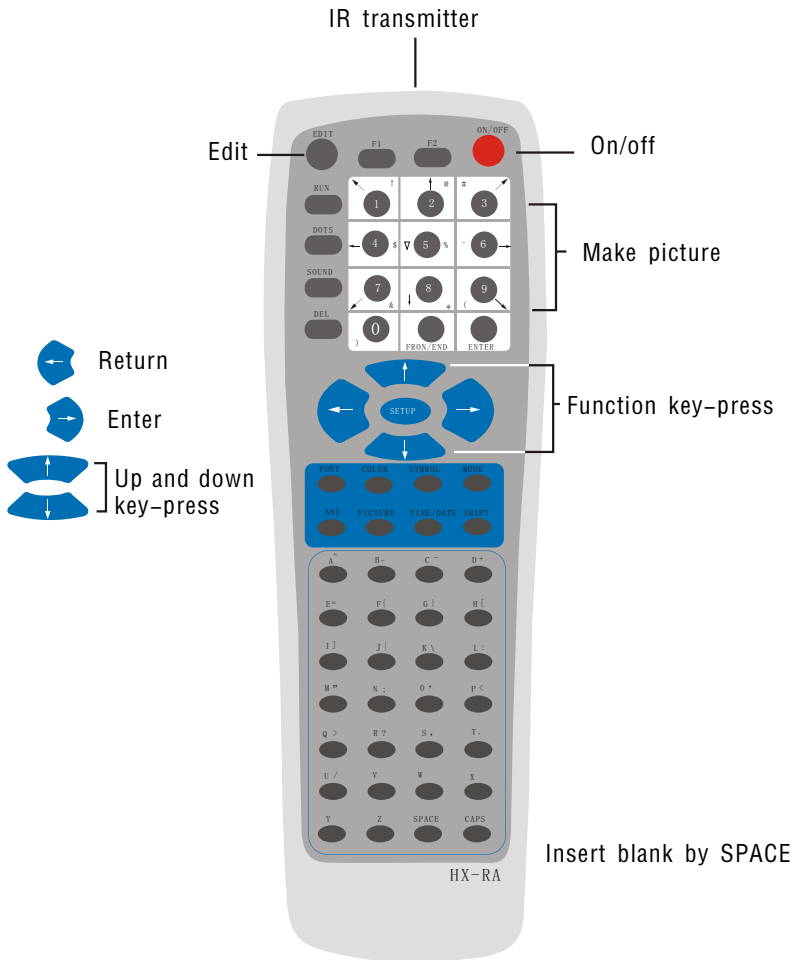

The start up messages when turn on the display first time.



Display time



Display date









Display type

Input simple text

The display effect as follows:









"Welcome" is the inputted text









Step		
1	Press EDIT , then 	
2	Press "0"	
3	Input " welcome " continuously	 " " is cursor(flash)
4	Press  to return and save	
5	Press ON/OFF twice for demo:	

Input advanced text

Create new text









1	Press EDIT , then 	
2	The file name such as "1" ,then press "1"	
3	Input the text your need,the last position is the blinking cursor	 " " is cursor. "1" is file name.
4	Press  to return and save	
5	Press ON/OFF twice for demo:	

Edit an existed text

1	Press EDIT , then 	
2	Press up or down key - press to choose (file0, file1...)	
3	Press  to enter text0	
4	The sign will load the saved text	 Cursor
5	Press  to return and save, press ON/OFF twice for demo.	







Edit text

Insert the time and date in the text







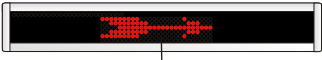

		
1	Press EDIT , then 	 
2	Press "0"	
3	Press TIME/DATE continuously until show DATEA.	 Cursor.
4	Press  to return and save, press ON/OFF twice for demo.	

Insert picture







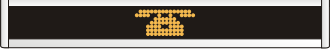

Attention: Please check whether the picture is existed. Please see PICTURE EDIT for edit picture.

1	Press EDIT , then 	 
2	Press "0"	
3	Press DOTS continuously until show DOT1	
4	Press  to return and save, press ON/OFF twice for demo.	 <div style="text-align: center;">Dot1</div>











Insert special symbol

1	Press EDIT , then	 
2	Press "1"	
3	Press PICTURE to choose special symbol If you need more pictures, then press  next  and PICTURE	 <div style="text-align: center;">choose special symbol</div>  <div style="text-align: center;">Next special symbol</div>
4	Press  to return and save, press ON/OFF twice for demo.	













Set font and color

1	Press EDIT , then 	 
2	Press "0"	
4	Press COLOR until show [GRN]	
5	Press FONT until show [SRF]	
6	Input text	
7	Press  to return and save, press ON/OFF twice for demo.	







Input upper and lower case and Enter

1	Press EDIT then 	 
2	Press "0"	
3	Input "IN"	
4	Press ENTER to return Press CAPS to change upper and lower case	
5	Press SHIFT to switch character and interpunction	
6	Press  to return and save, press ON/OFF twice for demo.	 







Move cursor

1	Press EDIT , then 	
2	Press function key-press to choose file until show "0" in the sign	
3	Press  to input text	 Cursor
4	Press  and  to move cursor	
5	Move the cursor to the right place and then input text or delete text	  
6	Press  to return Press ON/OFF twice for demo	

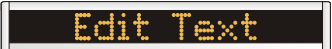











Switc the cursor from the front to the end

1	Press EDIT , then 	
2	Press "0"	
3	This is the information in the file"0" Press FRONT/END to switch the curcor from the front to the end.	 
4	Press  to confirm	















Text test

1	Press EDIT , then 	
2	Press "0"	
3	Input information: IN TIME ORDER	
4	Press SETUP until show "play test"	
5	Press  to test text	







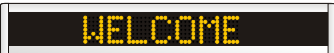



Set display text mode

1	Press EDIT , then 	
2	Press "1"	
3	Input text	
4	Press   until show "Disp mode"	
5	Press   until show RoLLIn Press  to confirm and return	
6	Press  to return and save. press ON/OFF twice for demo.	













Set display text speed

1	Press EDIT , then 	
2	Press "1"	
3	Input text	
4	Press SETUP  until show "Disp Speed"	
5	Press   until show "FASTER" then press  to confirm Attention:5 speed for choose,the red color is selected.	    
6	Press  , return to edit text. press ON/OFF twice for demo.	

Set text stop time

1	Press EDIT , then 	
2	Press "1"	
3	Input text	
4	Press SETUP  until show "Pause time"	
5	Press  to choose stop time, then press  to confirm	
6	Press  to return and save. press ON/OFF twice for demo.	









Delete text

1	Press EDIT , then 	 
2	Press  until confirm	
3	Press  to confirm	
4	Press SETUP , then press  until show "Del TEXT?"	
5	Press  , file "1" is deleted, and go back to previous page	 



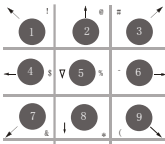
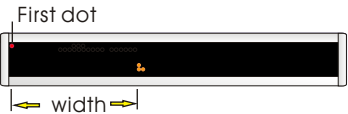

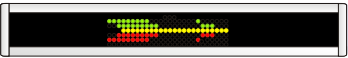

Edit picture

Create a new picture













Set cursor different state

<p>1</p>	<p>Press EDIT, then </p>	 
<p>2</p>	<p>Press "0"</p>	
<p>3</p>	 <p>Press the key to draw a picture.</p> <p>Press "5" cursor will show different state, flash fastest speed is for adding dot, the slower is across dot, the slowest is for deleting dots.</p> <p>Attention: Press continuously to change different color</p>	   
<p>4</p>	<p>Press  to return press ON/OFF twice for demo.</p>	













Edit an existed picture

<p>1</p>	<p>Press EDIT, then </p>	 
<p>2</p>	<p>Choose existed file picture text"0" and press  to open existed file.</p>	 
<p>3</p>	<p>Edit the picture refer to the chapter 3 of "create a new picuer"</p>	

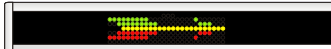













Set picture size

<p>1</p>	<p>Press EDIT, then </p>	 
<p>2</p>	<p>Press  to choose file "0"</p>	 
<p>3</p>	<p>Press SETUP then  and then  or  to choose, by up and down key-press to move display dots</p>	  <p style="text-align: center;">  Drawing dots width High= 7 dots </p>









Delete picture









1	Press EDIT , then 	 
2	Press  until show "Edit Dots"	 
3	Press  to confirm	
4	Press SETUP and  until show "Del Dots"	 
5	Press  to confirm file "0" is deleted, and return edit state.	

Change code





















Step		
1	Press 	
2	Press  to the next menu	
3	Press  to confirm	
4	Press  then  to the next menu	
5	Enter code to set mode, press 	
6	Finish set code, press  to save and return	 
7	If input two different codes, will show "Code Error" then need input code again	

Delete all texts or all pictures

1	Press EDIT , then 	
2	Press  and 	
3	Press  to confirm	 ↓ Delete all informations 

1	Press EDIT , then 	 
2	Press  and 	
3	Press  to confirm	 ↓ Delete all pictures? 

Set display time and date











1	Press EDIT , then 	
2	Press  then 	
3	Press 	
4	Press  then 	
5	Press  to choose press  or  to set time	
(4)	Press  to return press  to set date	
(5)	Press  to enter the modified state for time/date Press  or  to modify	
6	After set time and date, return to regular operation.	

Control voice







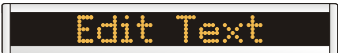

















Usually, you will hear "BIBI" voice when operate the sign, if you want to open the voice press SOUND.

Expanded mode







Set expanded mode

1	Press EDIT , then  until show select "Screen Setup"	
2	Press 	
3	Press 	
4	Press  to choose expanded mode, then press  to confirm	 <p style="text-align: center;">Basic mode</p>  <p style="text-align: center;">Expanded mode</p>
5	Press  to return and enter expanded mode.	

















Insert code and set code

1	Press EDIT	
2	Press  to the next menu	
3	Press  to confirm	
4	Press  then  to the next menu	
5	Enter code to set mode, press 	
6	Finish set code, press  to save and return If code error, please input the code again.	    <div style="text-align: right; margin-right: 50px;">Code error</div>
7	Press  to set screen	
8	Press  to "Code Setup" Press  into and press  or  to choose	  <div style="text-align: center; margin-left: 100px;">Unuse code</div>  <div style="text-align: center; margin-left: 100px;">Use code</div>
9	Change to new code, please refer to "Change code" .	









Edit display list

1	Press EDIT , then 	
2	Press  to enter display list	
3	In the previous text, there is file0, file1 and file2, choose any file to edit	
4	Press  to return and save	













Set text display time and date

1	Press EDIT , then 	
2	Press   until show file "0"	 <p style="text-align: center;">Text file name</p> 
3	Press SETUP then 	 <p style="text-align: center;">Date</p>
4	Press  to choose OFF and ON	
5	Return DISA DATE menu, press  TO choose	
6	Choose start time "START TIME"	 <p style="text-align: center;">Start time</p> 
7	Choose stop time, finish set to return and save.	  <p style="text-align: center;">stop time</p>









Delete display list

1	Press EDIT , then 	
2	Press 	
3	Press  until show "Del Play list"	
4	Press 	





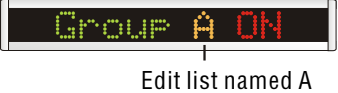

Display mode

1	Press EDIT , then 	
2	Press  then 	
3	Press  until show "Run Setup"	
4	Press  to confirm, finish set mode press  to confirm	  

Set turn on/off time

1	Press EDIT then 	
2	Press  to confirm	
3	Press 	
4	Set ON/OFF time list for edit four groups(A.B.C.D)	
5	Edit the start time of A, press  to set time	

Set screen number

1	Press EDIT , then 	
2	Until show Screen Setup, press  to confirm	
3	Choose until show" Set Device No.press  to confirm	
4	Press up and down key-press to set screen number.	











Input International characters

This kind of sign can input international charater.

Note:[SS5] font is not available for international charcter.



A	a	C	c	D	d	E	e	I	i	N	n	O	o	U	u	y	?	!	\$
Ä	â	Ç	ç	Ð	ð	É	é	Í	ï	Ñ	ñ	Ö	ô	Û	ü	ÿ	¿	¡	¢
Ä	ä	Č	č			Ê	ê	Î	î			Ë	ë	Û	û				£
À	à	Č	č				ë	ì					ò	ù					¥
À	á						è	í					ó	ú					f
Ä	á												õ						
Æ	ã												œ						
	æ																		
	a																		

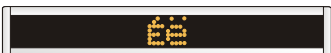



The example is to show you how to input international characters.

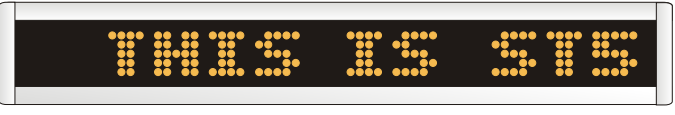
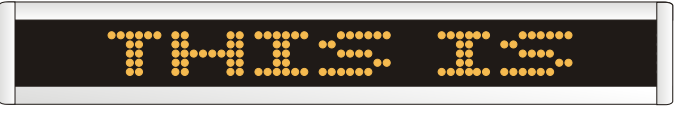
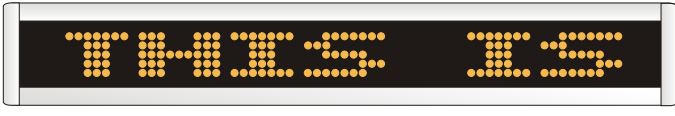

1	Press EDIT then 	
2	Press   until show file "0"	
3	Input txet "E", then press SYMBOL to change international characters Input text "e", then press SYMBOL to change international characters	   
	Press  to return and save, press ON/OFF twice for demo.	

Font

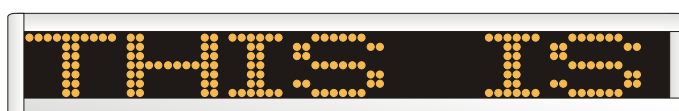
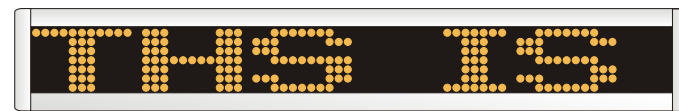
Examples for the different font as follows

5-font(=5LED pixel)	
Name	Example
[SS5]	
[ST5]	
[WD5]	
[WS5]	
[SML]	 <p>[WS7] is font, the front is red, shadow is green</p>

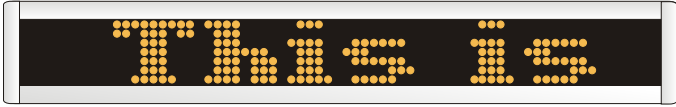
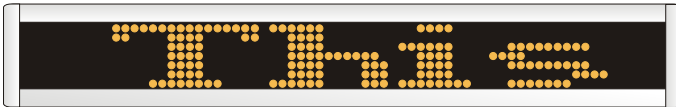
7-font(=7LED pixel)	
Name	Example
[SS7]	
[ST7]	
[WD7]	
[SD7]	
[WS7]	 <p>[WS7] is font, the front is red, shadow is green</p>

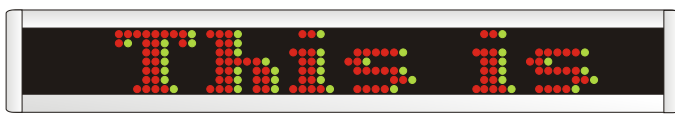
7-font(=7LED pixel)	
Name	Example
[SRF]	
[STF]	
[WDF]	
[WSF]	
[SDF]	 <p>[Sd7] is font, the front is red, shadow is green</p>

Control operation

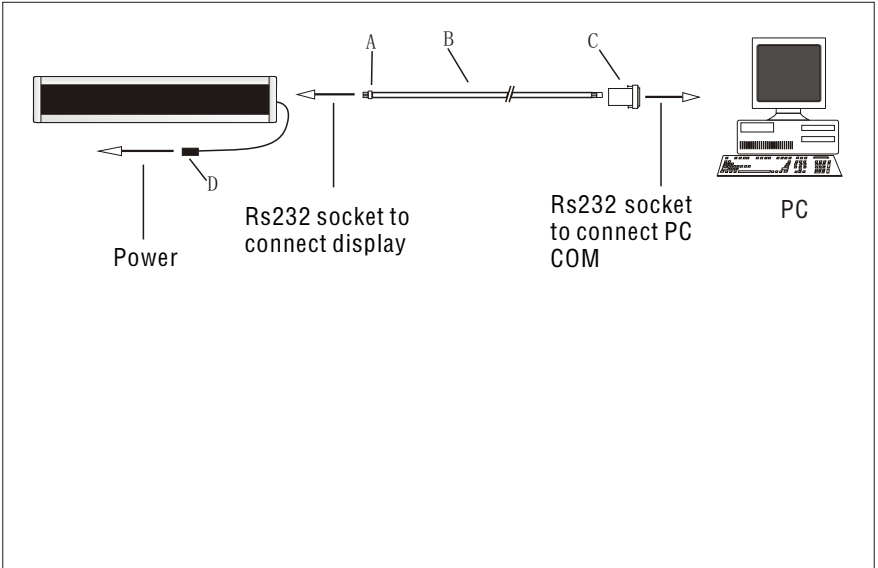

ITEM	PARTS	EXPLAIN
A		
B		
C		
D		

The manual shows how to exit information to display

Display can be installed On the wall or ceiling, firstly install the parts to two ends, then install the display.

Attention: the display is only installed in the indoor.

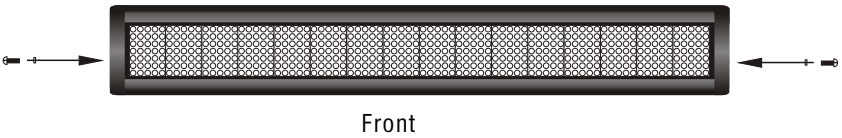
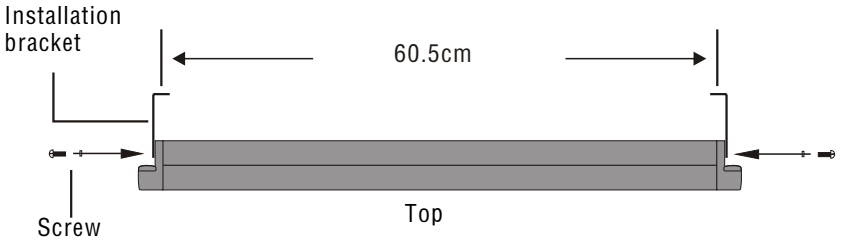

Install in the ceiling

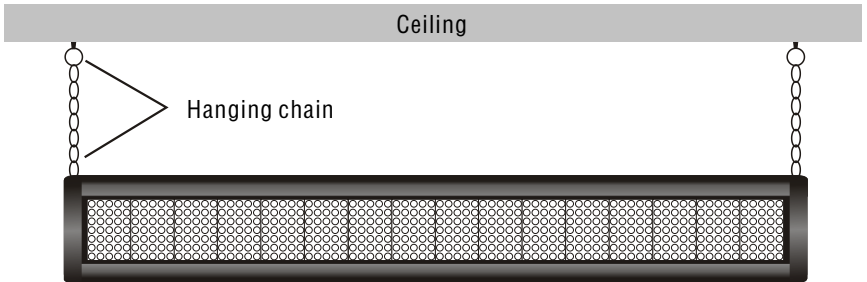
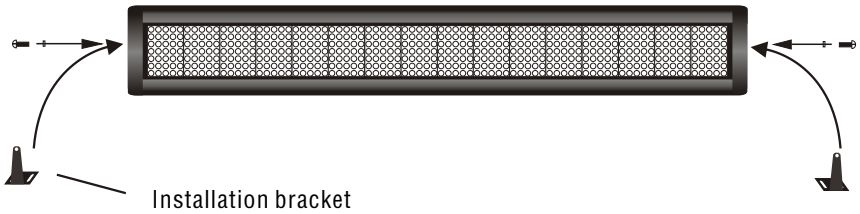

Specification

Weight (not including power and IR remote)	
Height	
Width	
Depth	
Power	
Surrounding	Environment :0-50 Humidity: not over 95%

The installation will not happen dangerous conflict.